



# ELECTROMAGNETIC FLOWMETER

USER MANUEL



## Table of contents

---

- 1- General
- 2- Installation
- 3- Basic Circuit
- 4- Specifications
- 5- Operation & Setup
- 6- Parameters Settings
- 7- Alarm Information
- 8- Troubleshooting

## 1. General

---

### 1.1. Intended Use

The electromagnetic flowmeters are designed exclusively to measure the flow and conductivity of electrically conductive, liquid media.

### 1.2. Certification



The device fulfils the statutory requirements of the following EC directives:

- Low Voltage Directive 2006/95/EC
- EMC Directive 2004/108/EC
- EN 61010
- EMC specification acc. to EN 61326/A1

The manufacturer certifies successful testing of the product by applying the CE marking.



### 1.3 Safety Instructions

This manual will assist you in installing, using and maintaining your flow meter. It is your responsibility to make sure that all operators have access to adequate instructions about safe operating and maintenance procedure.

#### Warning

For your safety, review the major warnings and cautions below before operating your equipment.

1. Use only fluids that are compatible with the housing material and wetted components of your meter.
2. When measuring flammable liquids, observe precautions against fire or explosion.
3. When handling hazardous liquids, always follow the fluids manufacturer's safety precautions.
4. When working in hazardous environments, always exercise appropriate safety precautions.
5. During meter removal, fluids may spill. Follow the fluids manufacturer's safety precautions for clean up of minor spills.
6. When tightening the meter, use a wrench only on the wrench flats.
7. For best results, calibrate the meter at least 1 time per year.

### 1.4. Product Description

Electromagnetic flow meters are intended for fluid measurement in most industries including water, wastewater, food and beverage, pharmaceutical and chemical.

There are two basic components of electromagnetic flow meter:

- 1) The Detector, which includes the flow tube, isolating liner and measuring electrodes, and
- 2) The Converter, which is the electronic device responsible for signal processing, flow calculation, display and output signals.

The materials of construction of the wetted parts (liner and electrodes) should be appropriate for the specifications on the intended type of service. Review of the compatibilities consistent with the specifications is recommended.

All Teksens electromagnetic flow meters are factory tested and calibrated.

**A calibration certificate is included in the shipment of each meter.**

### 1.5. Unpacking and Inspection

Upon receipt, examine your meter for visible damage. The meter is a precision measuring instrument and should be handled carefully. Remove the protective plugs and caps for a thorough inspection. If any items are damaged or missing, contact Teksens.

Make sure the flow meter model meets your specific needs. For your future reference, it might be useful to record this information on nameplate in the manual in case it becomes unreadable on the meter.

## 1.6. Specifications

<b>Measuring Principle</b>	Electromagnetic flow measurement on the basis of Faraday's Law.
<b>Flow Range</b>	0.03-10 m/s
<b>Turndown Ratio</b>	333:1
<b>Size</b>	10 to 2200 mm
<b>Min. Conductivity</b>	5 micromhos/cm
<b>Electrode Materials</b>	Standard: AISI316L Optional: Tantalum, Titanium, Hastelloy B/C
<b>Liner Material</b>	PTFE, Hard Rubber, PA
<b>Fluid Temperature</b>	Hard Rubber : 0...60°C - PTFE : -20...150°C - PA : 0...60°C
<b>Pressure Limits</b>	DN10...DN80 → PN40 / DN100...DN350 → PN16/ DN350 → < PN10 please consult Teksens for special requirements.
<b>Pressure Loss</b>	No pressure loss
<b>Coil Power</b>	Pulsed DC
<b>Ambient Temperature</b>	-10°C to 60°C for carbon steel body -30°C to 60°C for stainless steel body
<b>Protection</b>	IP67, IP68 optional for remote version "R"
<b>Pipe Spool Material</b>	316 Stainless Steel
<b>Sensor Housing Material</b>	Carbon Steel welded, optional AISI304, AISI316
<b>Flanges</b>	Carbon Steel - Standard (TS ISO 7005-1) 316 Stainless Steel – Optional
<b>Cable Length</b>	up to 300 m (please see length of connection cable)
<b>Mounting Position</b>	Vertical or Horizontal (please see installation)

## 1.7. Measurable Flow Rate Range:

DN		*Flow Range (l/sec)		*Flow Range (m <sup>3</sup> /h)	
mm	inch	Qmin	Qmax	Qmin	Qmax
10	¼"	0,0078	0,785	0,0282	2,827
15	½"	0,0176	1,767	0,0636	6,361
20	¾"	0,0314	3,141	0,1130	11,3
25	1"	0,0490	4,908	0,1767	17,67
32	1 ¼"	0,0804	8,042	0,2895	28,95
40	1 ½"	0,1256	12,65	0,4523	45,23
50	2"	0,1963	19,63	0,7068	70,68
65	2 ½"	0,3318	33,18	1,194	119,4
80	3"	0,5026	50,26	1,809	180,9
100	4"	0,7853	78,53	2,827	282,7
125	5"	1,227	122,7	4,417	441,7
150	6"	1,767	176,6	6,361	636,1
200	8"	3,141	314,1	11,30	1130
250	10"	4,908	490,8	17,67	1767
300	12"	7,068	706,8	25,44	2544
350	14"	9,621	962,1	34,63	3463
400	16"	12,56	1256	45,23	4523
450	18"	15,90	1590	57,25	5725
500	20"	19,63	1963	70,68	7068
600	24"	28,27	2827	101,7	10178
700	28"	38,48	3848	138,5	13854
800	32"	50,26	5026	180,9	18095
900	36"	63,61	6361	229	22902
1000	40"	78,53	7853	282,7	28274

## 1.8. Approvals

The devices are designed to meet state-of-the-art safety requirements in accordance with sound engineering practice. They have been tested and left the factory in a condition in which they are safe to operate.

The devices comply with the applicable standards and regulations in accordance with EN 61010-1 "Safety requirements for electrical equipment for measurement, control and laboratory use" and with the EMC requirements of IEC/EN 61326.

The measuring system described in this Operating Manual is therefore in conformity with the statutory requirements of the EC Directives. Teksens confirms successful testing of the device by affixing to it the CE mark.

## 2. Installation

### 2.1.1 Dimension and mounting

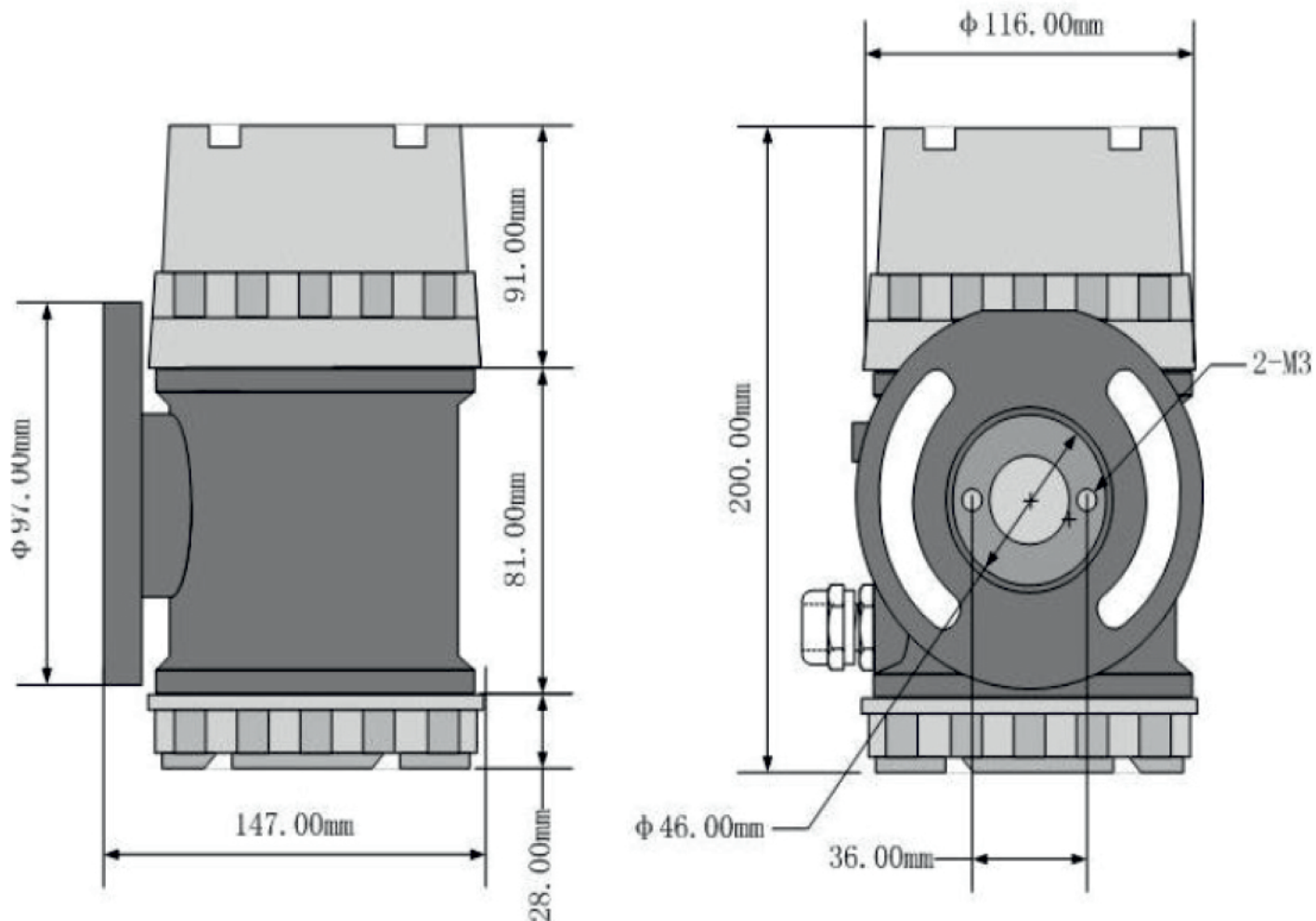

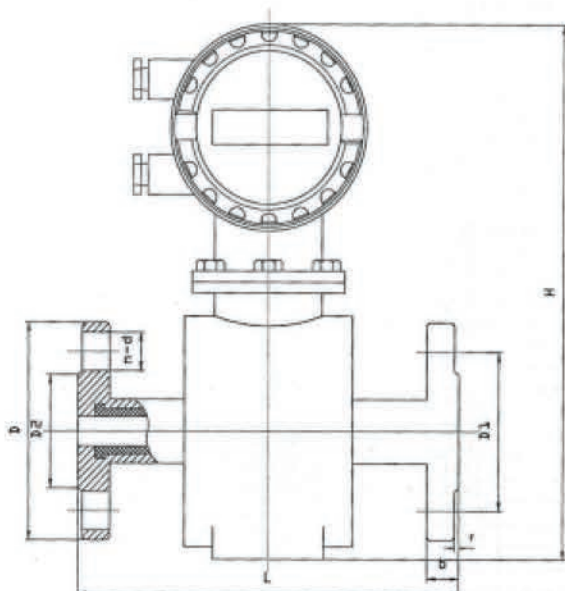

**Compact**

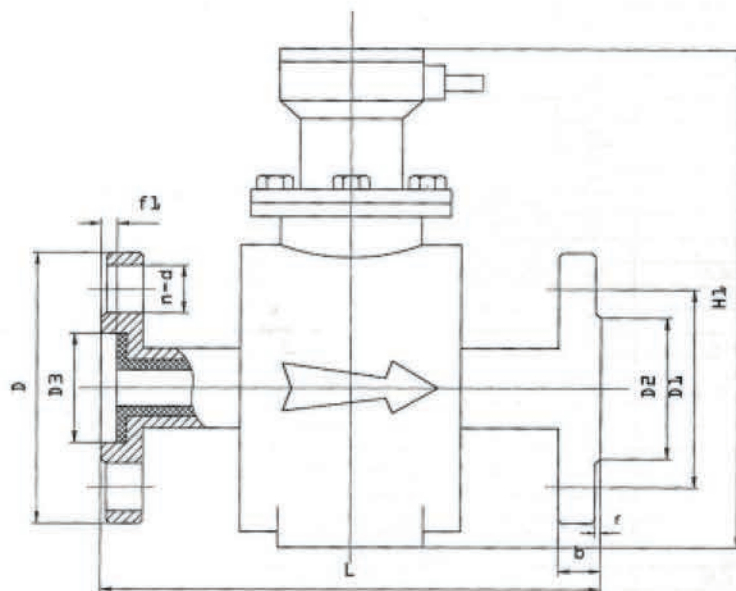

**Remote**

Diameter (mm)	Pressure Rating (Bar)	Dimension (mm)						
		H	H1	L	D	D1	n-d	b
10-15	40	360	220	160	95	65	4 × Φ 14	14
20		360	220	165	105	75	4 × Φ 14	16
25		360	220	200	115	85	4 × Φ 14	16
32		370	235	200	140	100	4 × Φ 18	18
40		370	235	200	150	110	4 × Φ 18	20
50		385	242	200	165	125	4 × Φ 18	22
65		400	256	250	185	145	8 × Φ 18	24
80		415	275	250	200	160	8 × Φ 18	24
100	1.6	435	295	250	220	180	8 × Φ 18	24
	2.5	440	300	250	230	190	8 × Φ 22	26
125	1.6	465	325	250	250	210	8 × Φ 18	24
	2.5	475	335	250	270	220	8 × Φ 26	28
150	1.6	497	355	300	285	240	8 × Φ 22	26
	2.5	505	363	300	300	250	8 × Φ 26	28
200	1.6	550	410	350	340	295	8 × Φ 22	28
	2.5	560	420	350	360	310	8 × Φ 26	32
250	1.6	610	488	450	405	355	12 × Φ 26	30
	2.5	620	498	450	425	370	12 × Φ 30	32
300	1.6	660	520	500	460	410	12 × Φ 26	30
350	1.6	720	576	500	520	470	16 × Φ 26	32
400	1.0	765	625	600	565	515	16 × Φ 26	32
450	1.0	825	685	600	615	565	20 × Φ 26	32
500	1.0	878	735	600	670	620	20 × Φ 26	32
600	1.0	988	845	600	780	725	20 × Φ 30	34
700	1.0	1095	952	700	895	840	24 × Φ 30	36
800	1.0	1208	1064	800	1015	950	24 × Φ 33	36
900	1.0	1310	1167	900	1115	1050	28 × Φ 33	38
1000	1.0	1413	1269	1000	1230	1160	28 × Φ 36	38

### 2.1.2 Transportation and Handling

Do not lift the detector from the Converter housing, the junction box or the connecting cable. Use lifting lugs for larger sizes is recommended. Very large meter sizes are packed and crated with the meter laying on its side for shipping safety and stability reasons. In order to lift the meter in vertical position, it's recommended to use a sling rigged method as shown below.



**Warning :** Never introduce the forklift, chains, wire slings or any other sharp object inside the flow tube for lifting or handling purpose. This could permanently damage the isolating liner and could render the meter inoperable.

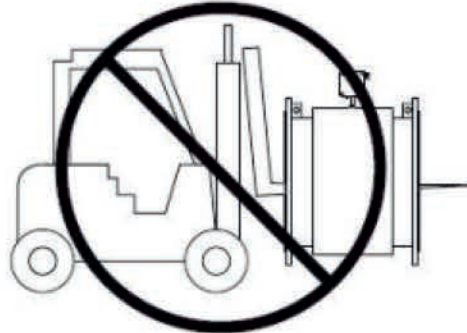
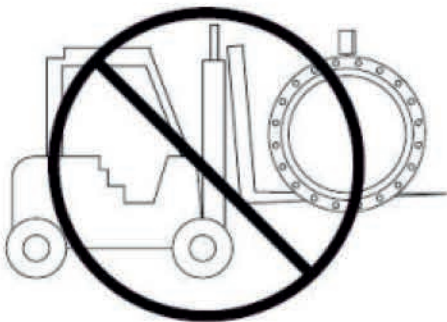

If using a forklift, do not lift the detector from its body between the flanges. The housing could be accidentally dented and permanent damage could be caused to the internal coil assemblies.

### 2.1.3 Storage

- Pack the measuring device in such a way as to protect it reliably against impact for storage (and transportation). The original packaging provides optimum protection.
- The storage temperature corresponds to the operating temperature range of the measuring transmitter and the appropriate measuring sensors
- Do not remove the protective plates or caps on the process connections until you are ready to install the device. This is particularly important in the case of sensors with PTFE linings.
- The measuring device must be protected against direct sunlight during storage in order to avoid unacceptably high surface temperatures.
- Choose a storage location where moisture does not collect in the measuring device. This will help prevent fungus and bacteria infestation which can damage the liner.

### 2.1.4. Mounting

Recommended positions for sensor installation

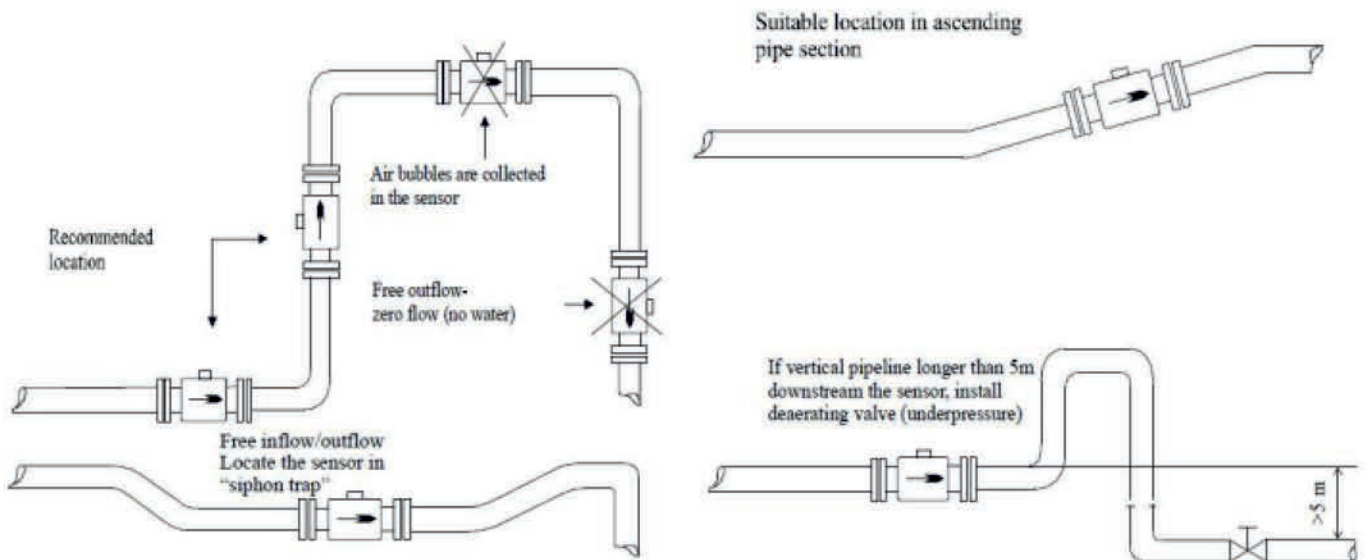

To avoid any measurement errors which are caused by air bubbles or failures on the lining, pay attention to the following recommendations:

During assembling correctly seat the sensor, tighten screws uniformly and move on a diagonal one after another.

It should be noted that the parallelism of flanges has a greater effect on packing than excessive tightening forces on curved and seated flanges.

The sensor must be installed inside piping so that the axis of sensor electrode is always horizontal.

A PTFE (teflon) lining calls for extra care during handling and assembly. During installation/operation avoid excessive underpressure in pipes. Please do not change and damage the outlet extension on both ends of the sensor. The sensors are shipped from the factory with special covers to avoid any shape deformations. (PTFE elastic memory should cause a partial compensation in future). Please remove the covers just before installation, and when you insert it between counterflanges, replace by a number of smooth metal sheet pieces which are removed just before tightening the bolts.

**Packing** – The extended part of lining does not operate properly as a seal, hence appropriate packing must be inserted between sensor and pipeline. If the packing protrudes into a flow profile at any point, this will cause turbulence and reduce the measurement quality.

During installation, make sure the sensor slides into piping if the pipeline is not flexible enough. It is recommended that installation inserts (especially for greater internal diameters) should be used. During installation of the sensor, counterflanges must not be welded (danger of the sensor lining failure).

### Installation of Pump

Do not install the sensor on the intake side of a pump. This precaution is to avoid low pressure and the consequent risk of damage to the lining of the measuring tube.



### 2.1.5 Required Lengths of Straight Runs

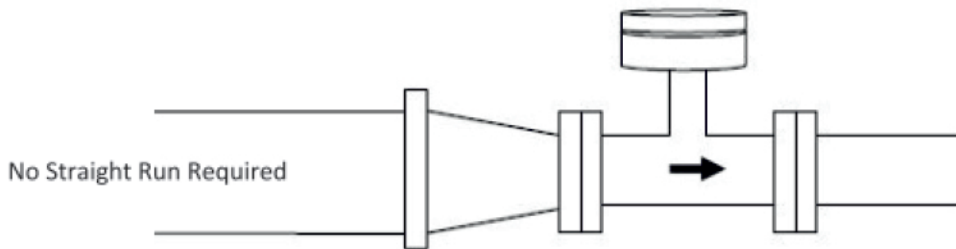
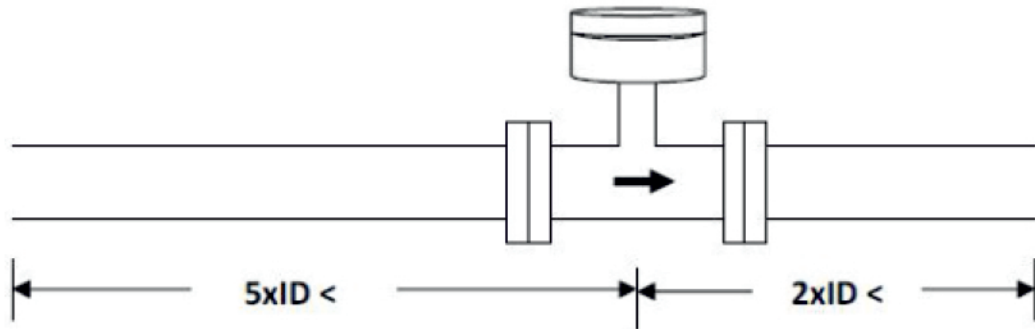

### 2.1.6 Vibrations and Magnetic Fields

Vibrations of the pipes should be avoided by anchoring the pipe before and after the sensor.

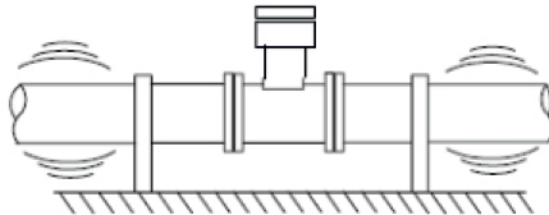

Strong magnetic fields close to the sensor should be avoided

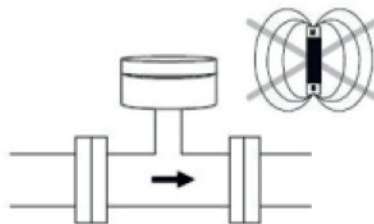

### 2.1.7. Grounding of Sensor

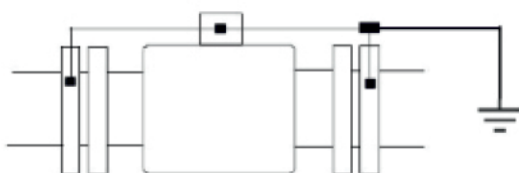

Grounding in metal pipes

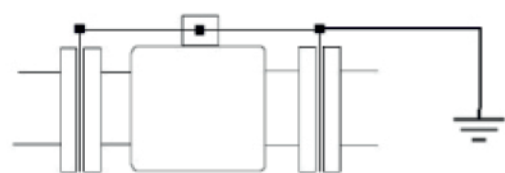

Grounding in plastic pipes

## 2.2 Electrical Wiring Table

Function	Symbol	Description
Pulse Output	POUT	Frequency (pulse) output
Alarm Output	ALM1	Alarm Output for Upper Limit
Alarm Output	ALM2	Alarm Output for Low Limit
RS485 (Optional)	TRX+	Communication RS485+
	TRX-	Communication RS485-
Analog Current Output	IVIN	Two Routes 24V Power Supply
	IOUT	Analog Current Output
Power Supply	L or (-)	230VAC live or 24V DC (-)
	N or (+)	230VAC neutr or 24V DC (+)
		Ground
Common	Comm	Frequency, Pulse and Current Common (GND)
	Comm	Frequency, Pulse and Current Common (GND)

## 2.3 Signal Outputs

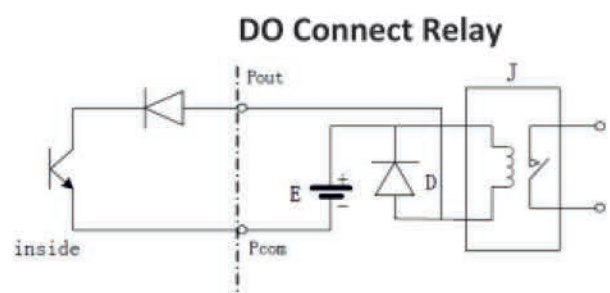
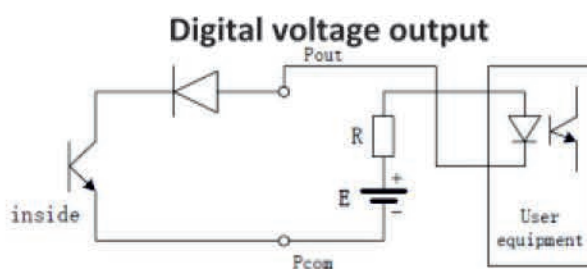
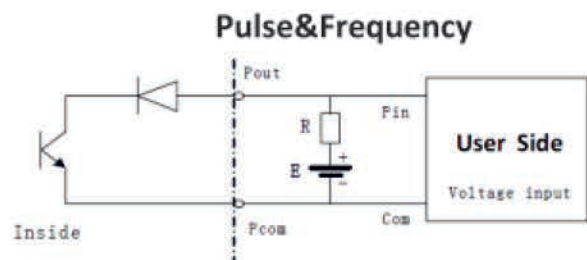
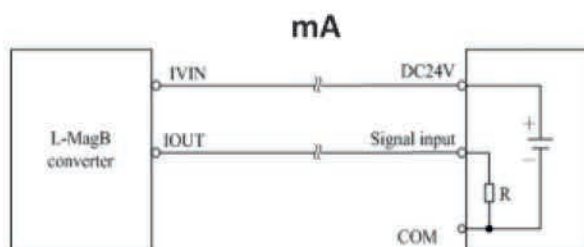

## Table of digital output parameter: POUT

Parameter	Test Condition	Mini	Typical	Max	Unit
Voltage	IC=100 mA	3	24	36	V
Current	Vol≤1.4V	0	300	350	mA
Frequency	IC=100mA Vcc=24V	0	5000	7500	HZ
High voltage	IC=100mA	Vcc -10%	20-36 VDC or 85-250 VAC	Vcc +10%	V
Low Voltage	IC=100mA	0.9	1.0	1.4	V

## Frequency output

Digital output means frequency output and pulse output, and both of them use the same output point, so user can choose only one type of them but not both.

Frequency output range is 0 to 5000Hz, and corresponding the percent of flux

$$F = \frac{\text{Measuring Value}}{\text{Full Scale}} \times \text{frequency range}$$

The up limit of frequency output can be adjusted. It can be chosen from 0 to 5000Hz, and also can be chosen low frequency: such as 0 to 1000Hz or 0 to 5000Hz.

Frequency output mode can be used in control application, because it responses the percent flux.

Users can choose pulse output when the equipment is applied to count.

## Pulse Output

Pulse output mainly applies in count mode. A pulse output delegates a unit flux, such as 1L or 1 M3 etc. Pulse output unit divide into 0.001L, 0.01L, 0.1L, 1L, 0.001 M3, 0.01 M3, 0.1 M3, 1 M3 .When the pulse unit is selected, please notice the match of the flux range of flowmeter and pulse unit. For volume flux, count formula as follows:

$$Q \text{ (l/sec)} : 0,0007854 \times ID^2 \times V$$

$$Q \text{ (m3/sec)} : 0,0007854 \times ID^2 \times V \times 10^{-3}$$

Where ; ID : Inside diameter (mm) V : Velocity ( m/sec)

The oversize flux and too small pulse unit will be made the pulse output over the up limit.

Generally, pulse output should be controlled below 3000 Pulses/Sec.

Otherwise, pulse output is different from frequency output. When pulse output cumulates a pulse unit, it exports a pulse. Therefore, pulse output is not equality. Generally, measure pulse output should choose to count instrument, but not frequent instrument.

## Grounding

Contact area of copper Connector PE on Converter Cabinet for grounding should be larger than 1.6mm<sup>2</sup>.Contact resistance should be less than 10Ω.

## Maintenance

No special maintenance work is required.

When cleaning the exterior of measuring devices, always use cleaning agents that do not attack the surface of the housing and the seals.

### 3. Basic Circuit

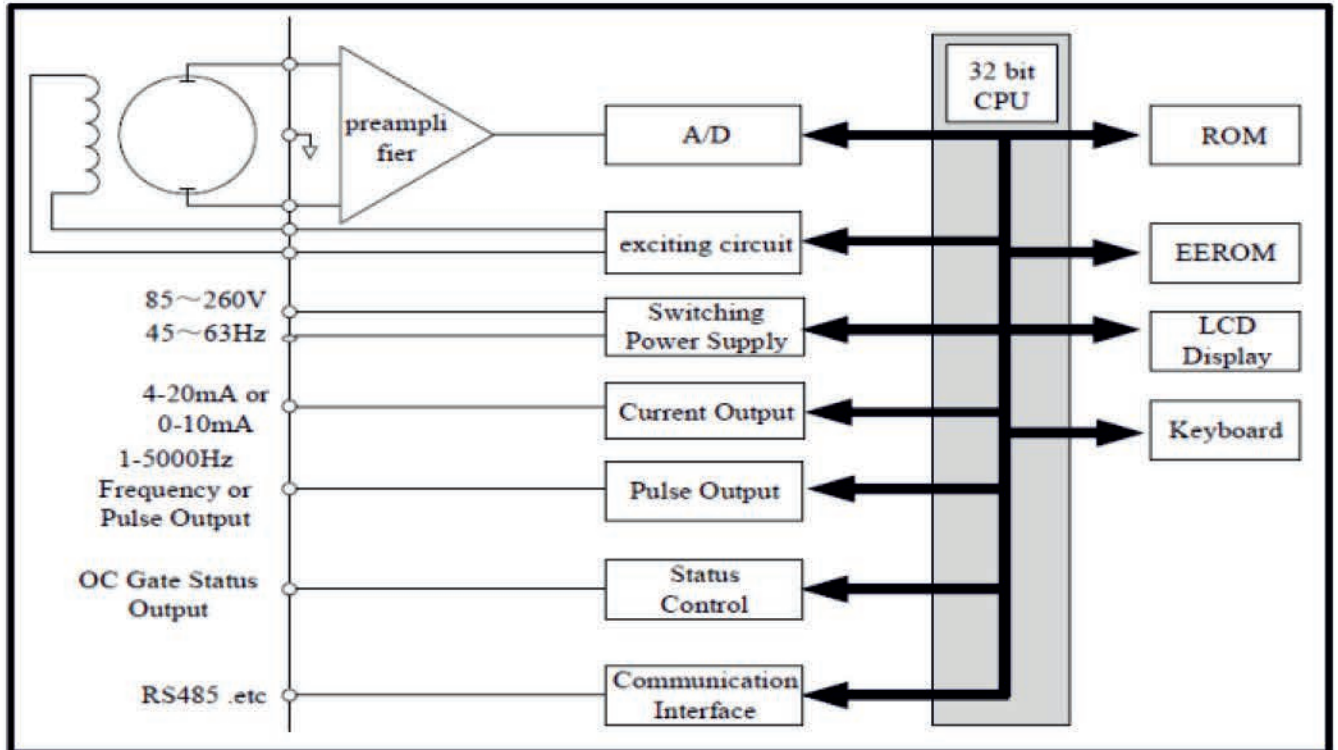

#### Working Principle:

The converter supplies exciting current to the coil of flowmeter's sensor (Detector); the main amplifier amplifies the electromotive force from the sensor and converts it into standard signals of current or frequency so that the signals can be used for displaying, controlling and processing. Structure of converter circuit is shown in above figure

### 4. Specifications

- Exciting current can be selected for 125mA、 187.5mA ;
- Velocity range: 0.1 to 15m/s,current speed resolution: 0.5mm/s;
- AC high-frequency switching power, range of voltage: 85VAC to 250VAC
- DC 24V switching power, range of voltage: 20VDC to 36VDC
- Network function: MODBUS、 HART Communication (Optional)

#### 4.1 Especial Function

- Recording time when power turn-off, to record power broken time of instrument system automatically and recruit to count the missing flux
- Recording function of hour gross, to record the flux gross by hour, fit for timed measure;

#### 4.2 Normal Operating Conditions

- Ambient Temperature Ranges:  $-10 \sim +60^{\circ}\text{C}$
- Relative Humidity: 5%~90%;
- Power Supply: 85...250V, 45~63Hz ( single-phase AC) or 20...36VDC
- Dissipation Power: < 20W

### 4.3 Measure Precision

Range (m/s)	Accuracy
0,1-0,3	± 0,25 % FS
0,3-1	± 0,5 % R
1-15	±0,5 % R

### 4.4 Digital Frequency Output

Frequency Output Range	1...5000 Hz
Output Electric Isolate	Photoelectric Isolate > 1000 V
Frequency Output Capacity	Field-effect transistors Output Maximum Voltage: 36V DC
Maximum Current	250 mA

### 4.5 Digital Pulse Output

Pulse Output Range	1... 100 Pulse/s
Pulse Output Value	0.001-1.000 m <sup>3</sup> /cp; 0.001-1.000 Liter/cp
Pulse Output Capacity	Field-effect transistors Output Maximum Voltage: 36V DC
Maximum Current	250 mA

### 4.6 Alarm output

Alarm Output Junction	ALMH: Upper Limit; ALML: Lower Limit
Alarm Output Capacity	Field-effect transistors Output Maximum Voltage: 36V DC
Maximum Current	250 mA

### 4.7 Digital Communication And Protocol

MODBUS interface	RTU; Electric isolate 1000V ;
HART interface	Be compliant with HART Protocol; Parameters can be set by hand-held device
Profibus , RS232 or RS485	

## 5. Operation & Setup

### 5.1 Keys and Display

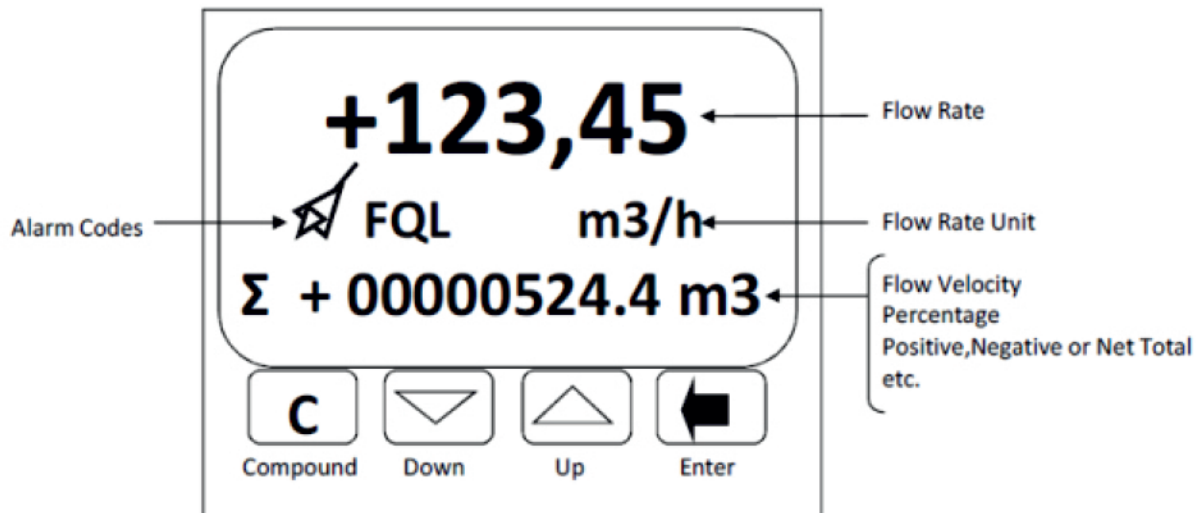

When measuring, pushing down “Compound Key + Enter” will appear password of changing state, base on distinction of secrecy, and change the password as we provide. Then pushing “Compound Key + Enter” again, and you can enter the state of setting parameter. If want to return to the running state, push “Enter” for several seconds.



## 6. Parameters Setting

### 6.1.1 Keys function

a) Keys' function for self-testing

 : Selecting displayed data on lower line in turn;

 : Selecting displayed data on higher line in turn;

 +  : Come into parameter setting

 : Press it to come into the picture of select function.

At measuring  
seconds to adjust **LCD contrast**.

key + “Down” key for several

b) Function keys for parameters setting

“Down” key	Subtract 1 from the number at cursor area;
“Up” key	Plus 1 to the number at cursor area;
“Compound” key + “Down” key	Cursor turns left;
“Compound” key + “Up” key	Cursor turns right;
“Enter” key	Enter/Exit submenu;
“Enter” key	Press for two seconds under any state to return measure status.

It returns to the measure status automatically after 3 minutes without any action under parameter setting status;

### 6.1.2 Function Keys for Parameters Setting

At measuring status, press “Compound” + “Enter” keys getting to the select of parameter and transfer password (0000), and then reset the password with one of the new passwords that are provided by manufacturer. Press the “Compound” + “Enter” keys to work in Parameters Setting Way. There are 6 Passwords in design and Four Passwords for operators, the other Two Password are fixed passwords for system operation.

### 6.1.3 Functions Select Menu

Press “Compound” + “Enter” keys to the functions select menu, push “Up” or “Down” keys to select, there are three functions:

Code	Functions	Notes
1	Parameters Set	Enter Parameters Setting
2	Clr Total Rec	Total Flow Reset
3	Fact Modif Rec	Check the factor's Modification Record

### 6.1.3.1 Parameters Set

Press “Compound”+“Enter” key, it displays “Parameters Set” function. Input password. Press “Compound”+“Enter” key, it getting to Parameters Setting status.

### 6.1.3.2 Clr Total Rec

To push “Compound”+“Enter” keys getting to the select of parameter, then push “Up” key to “Clr Total Rec”,input the passwords. When the passwords becomes “00000”, this function is done, the gross is 0 in the instrument.

### 6.1.3.3 Fact Modif Rec

To push “Compound”+“Enter” keys getting to the select of parameter, then push “Up” key to “Fact Modif Rec”(Detail consult the AppendixFive)

### 6.1.4 Setting Parameters in Menu

There are 54 parameters of –CM series, user can set every parameter. The List of Parameters is shown below:

Code	Parameter words	Setting Way	Grades	Range
1	Language	Select	2	English
2	Comm Adres	Set count	2	0~99
3	Baud Rate	Select	2	600~14400
4	Snsr Size	Select	2	3~3000
5	Flow Unit	Select	2	L/h、L/m、L/s、m3/h、 m3/m、m3/s
6	Flow Range	Set count	2	0~99999
7	Flow Rspns	Select	2	1~50
8	Flow Direct	Select	2	Plus/ Reverse
9	Flow Zero	Set count	2	0~±9999
10	Flow Cutoff	Set count	2	0~599.99%
11	Cutoff Ena	Select	2	Enable/Disable
12	Total Unit	Select	2	0.001m3~1m3、 0.001L~1L、
13	SegmaN Ena	Select	2	Enable/Disable
14	Analog Type	Select	2	0~10mA /4~20mA
15	Pulse Type	Select	2	Freque / Pulse
16	Pulse Fact	Select	2	0.001m3~1m3、 0.001L~1L、
17	Freque Max	Select	2	1~5999 HZ
18	Mtsnsr Ena	Select	2	Enable/Disable
19	Mtsnsr Trip	Set count	2	59999 %
20	Alm Hi Ena	Select	2	Enable/Disable
21	Alm Hi Val	Set count	2	000.0~599.99 %
22	Alm Lo Ena	Select	2	Enable/Disable
23	Alm Lo Val	Set count	2	000.0~599.99 %
24	Sys Alm Ena	Select	2	Enable/Disable
25	Clr Sum Key	Set count	3	0~99999
26	Snsr Code1	User set	4	Finished Y M
27	Snsr Code2	User set	4	Product number
28	Field Type	Select	4	Type1,2,3
29	Sensor Fact	Set count	4	0.0000~5.9999
30	Line CRC Ena	Select	4	Enable/Disable
31	Lineary CRC1	User set	4	Set Velocity

32	Lineary Fact 1	User set	4	0.0000~1.9999
33	Lineary CRC2	User set	4	Set Velocity
34	Lineary Fact 2	User set	4	0.0000~1.9999
35	Lineary CRC3	User set	4	Set Velocity
36	Lineary Fact 3	User set	4	0.0000~1.9999
37	Lineary CRC4	User set	4	Set Velocity
38	Lineary Fact4	User set	4	0.0000~1.9999
39	FwdTotal Lo	Correctable	5	00000~99999
40	FwdTotal Hi	Correctable	5	00000~9999
41	RevTotal Lo	Correctable	5	00000~99999
42	RevTotal Hi	Correctable	5	00000~9999
43	PlsntLmtEna	Select	5	Enable/Disable
44	PlsntLmtVal	Select	5	0.010~0.800m/s
45	Plsnt Delay	Select	5	400~2500ms
46	Pass Word 1	User correct	5	00000~99999
47	Pass Word 2	User correct	5	00000~99999
48	Pass Word 3	User correct	5	00000~99999
49	Pass Word 4	User correct	5	00000~99999
50	Analog Zero	Set count	5	0.0000~1.9999
51	Anlg Range	Set count	5	0.0000~3.9999
52	Meter Fact	Set count	5	0.0000~5.9999
53	MeterCode 1	Factory set	6	Finished Y /M
54	MeterCode 2	Factory set	6	Product Serial No

Parameters of converters can decide the running status, process and output ways as well as state of output. Correct option and setting of parameters can keep the converters running optimally and get higher accuracies of output both in display and in measurement.

There are 6 grades of passwords for setting parameters function. Grades 1 to grade 5 of passwords are for users and grade 6 of password is for manufacturer. Users can reset their passwords of grades 1 to 4 in grade 5.

Users can check converters parameters in any grade of password. However, if users want to change parameters of converters, different grade of parameters have to be used by the users.

**Grade 1 of password (set by manufacturer as 00521): users can only read parameter.**

**Grade 2 of password (set by manufacturer as 03210): users can change 1~24 parameters.**

**Grade 3 of password (set by manufacturer as 06108): users can change 1~25 parameters.**

**Grade 4 of password (set by manufacturer as 07206): users can change 1~38 parameters.**

**Grade 5 of password (Fixed): users can change 1~52 parameters.**



password. Grades 1~3 can be set by any one who can be chosen by users.

## 6.2 Details Parameters

### 6.2.1 Language

There are 2 languages for –CM series converter operation. They can be set by users according to the users needs.

### 6.2.2 Comm Addres

It means this instrument's address when communicates with many, and has 01~99, holding the 0.

### 6.3.3 Baud Rate: 600, 1200, 2400, 4800, 9600, 19200

### 6.3.4 Snsr Size: 3mm to 3000mm

### 6.3.5 Flow unit: (L/s、 L/m、 L/h、 m3/s、 m3/m、 m3/h)

### 6.2.6 Flow Range (Change this value will affect other parameters or output)

Flow range means upper limit value, and lower limit value is set "0" automatically. Pulse output will not affect.

### 6.2.7 Flow Rspns

It means time of filter measure value. The long one can enhance the stability of flow display and output digital, and fits for gross add up of pulse flow; the short one means fast respond rate, and fits for production control.

### 6.3.8 Flow Direct

If users think the direct and design are differ, just change the direct parameter is OK, but not change exciting or signal.

### 6.2.9 Flow zero

Make sure the sensor is full of flow, and the flow is stillness. Flow zero is shown as velocity of flow, mm/s.

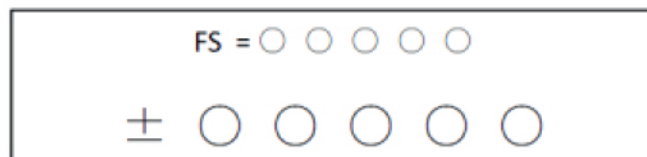

Converter's zero-flow correction displays as below:

Upper small words: FS means measure value of zero;

Lower large words: correction value of zero.

When FS is not "0", please set FS = 0.

**Note:** if change the value on next line and FS increases, please change the "+, -" to correct FS to zero. Flow zero is the compound value of the sensor, and should be recorded in sensor list and band. The unit will be mm/s, and the sign will be opposite with correction value.

Under the same flow, the smaller pulse, the higher frequency output, and the smaller error will be. The highest pulse output is 100cp/s, and mechanism electromagnetic counter can get 25 frequency/s.

#### **6.2.17 Freque Max**

Frequency output range is as the upper limit of flow measure, just the percent flow 100%. Frequency output upper limit can be selected between 1~5000Hz.

#### **6.2.18 Mtsnsr Ena**

The state of empty pipe can be detected with the function of converter. In the case of Empty Pipe Alarm, if the pipe was empty, the signals of analog output and digital output would be zero and displayed flow would be zero.

#### **6.2.19 Mtsnsr Trip**

When the pipe is full of liquid (whether flowing or not), the parameter of "Mtsnsr" could be modified more easily. The parameter displayed upper line is real MTP, and the parameter displayed bellow is the "Mtsnsr trip" that should be set. When setting "Mtsnsr trip", you could be according to the real MTP, the value that should be set is usually three to five times of real MTP.

#### **6.2.20 Alm Hi Ena**

Users can choose "Enable" or "Disable".

#### **6.2.21 Alm Hi Val**

The parameter of upper limit alarm is percentage of flow range and can be set in the way of setting one numerical value between 0%~199.9%.When the value of flow percentage is larger than the value of setting value, the converter outputs the alarm signal.

#### **6. 2.22Alm Lo Val**

The same as upper limit alarm.

#### **6.2.23 Sys Alm Ena**

Selecting Enable will have the function, and selecting Disable will cancel the function.

#### **6.2.24 Clr Sum Key**

User use more than 3 byte code to enter ,Then set this password in Clr Total Rec.

#### **6.2.25 Snsr Code**

It is referred to the produced date of sensor and the serial number of product that can keep the sensors coefficient right and accurate.

#### **6.2.26 Sensor Fact**

"Sensor Coefficient" is printed on the Label of the sensor when it is made in factory. The "sensor coefficient"has to be set into Sensor Coefficient Parameter when it runs with converter.

#### **6.2.27 Field Type**

affords three exciting frequency types: 1/16 frequency (type 1), 1/20frequency (type 2), 1/25 frequency (type3) The small-bore one should use 1/16 frequency, and large-bore one should use 1/20 or 1/25 frequency.

When using, please select type 1 first, if the zero of velocity is too high, select the type 2 or type 3.

### 6.2.10 Flow cutoff

Flow cutoff is set in percentage of Upper Limit Range of flow, and users can delete all Negligible Small Signals of flow volume, velocity and percentage out of displaying and outputting them. Sometimes user can delete output of current output signal and frequency (pulse) output signal only to have flow, velocity and percentage being displayed.

### 6.2.11 Total Unit

Converter display is counter with 9 bits, and the max is 999999999.

Flow integrator value: 0.001L, 0.010L, 0.100L, 1.000L

0.01 m<sup>3</sup>, 0.010m<sup>3</sup>, 0.100 m<sup>3</sup>, 1.000 m<sup>3</sup>;

### 6.2.12 SegmaN Ena

When “SegmaN Ena” is “enable”, if the flow flows, the sensor will export pulse and current. When it is “disable”, the sensor will export pulse as “0” and current as “0”(4mA or 0mA) for the flow flows reversals.

### 6.2.13 Output currents

0~10mA or 4~20mA is available

### 6.2.14 Analog Type

Frequency Output and Pulse Output.

Frequency Output is continuous square waveform and Pulse output is a serial wave of square wave. Frequency Output is mainly used for instant flow and total integrated flow in short time measurement. Frequency output can be chosen in equivalent frequency unit and volume of integrated flow can be displayed. Frequency Output can be used in long time measurement for total integrated flow with volume units.

### 6.2.15 Pulse Type

Frequency output and pulse output are usually from OC gates so that DC power supplies and load resistors have to be required

### 6.2.16 Pulse Fact

Equivalent pulse Unit is referred to one pulse for corresponding flow. The range of pulse equivalent can be chosen:

Pulse Equivalent	Flow	Pulse Equivalent	Flow
1	0.001L/cp	5	0.001m <sup>3</sup> /cp
2	0.01L/cp	6	0.01m <sup>3</sup> /cp
3	0.1L/cp	7	0.1m <sup>3</sup> /cp
4	1.0L/cp	8	1.0m <sup>3</sup> /cp

**Note: Demarcate on which exciting type, working on it only.**

#### **6.2.28 FwdTotal Lo, hi**

Positive total volume high byte and low byte can change forthcoming and reverse total value, and be used to maintenance and instead.

User use 5 byte code to enter, and can modify the positive accumulating volume ( $\Sigma+$ ). Usually, it is unsuitable to exceed the maximum the counter set(999999999).

#### **6.2.29 RevTotal Lo, hi**

User use 5 byte code to enter, and can modify the negative accumulating volume ( $\Sigma-$ ). Usually, it is unsuitable to exceed the minimum the counter set(999999999).

#### **6.2.30 PlsntLmtEn**

For paper pulp, slurry and other serosity, the flow measure will have "cuspidal disturb", because the solid grain friction or concussion the measure electrode. –CM series converters use variation restrain arithmetic to conquer the disturbing by designing three parameters to select disturb character.

Set it "enable", start variation restrain arithmetic; set it "disable", close variation restrain arithmetic.

#### **6.2.31 PlsntLmtVI**

This coefficient can disturb the variation of cuspidal disturb, and calculate as percent of flow velocity, thus ten grades: 0.010m/s, 0.020m/s, 0.030m/s, 0.050m/s, 0.080m/s, 0.100m/s, 0.200m/s, 0.300m/s, 0.500m/s, 0.800m/s, and the smaller percent, the higher delicacy of cuspidal restrain.

**Note: when using it, must test for select by the fact, and sometimes it is not the higher delicacy is good.**

#### **6.2.32 PlsntDelay**

This coefficient can select the width of time of restrain cuspidal disturb and the unit is ms. If the duration is shorter than flow change in some time, –CM series will think it is cuspidal disturb, and if it is longer, –C series will think it is natural. It also needs to select parameter in fact.

#### **6.2.33 User's password 1~4**

Users can use 5 grades of passwords to correct these passwords.

#### **6.2.34 Analog Zero**

When the converters are made in the factory, output current has been calibrated to zero scale, that is, accurate 0mA or 4mA output.

#### **6.2.35 Anlg Range**

When the converters is made in the factory, output current have been calibrated to full scale, that is, accurate 10mA or 20mA output.

#### **6.2.36 Meter Fact**

This fact is the special one of sensor-made-factory and the factory use this fact to unite –CM series electromagnetic flowmeters converters to make sure all the instruments can interchange by 0.1%.

## 7. ALARM INFORMATION

-C series intelligent converters have self-diagnose function. Without trouble of power and hardware circuit, the normal trouble can be alarmed correctly. This information displays on the left of LCD. The explanation of Alarm as below:

<b>FQH</b>	<b>High flow limit alarm</b>
<b>FQL</b>	<b>Low flow limit alarm;</b>
<b>FGP</b>	<b>Empty pipe alarm;</b>
<b>SYS</b>	<b>System exciting alarm</b>

## 8. TROUBLESHOOTING

Symptom	Probable Cause	Solution
No Display	1. No power	Apply correct power
	2. Fuse blown	Replace a fuse with same parameter
	3. Contrast of LCD is too low	Increase the contrast
Empty Pipe Alarm	1. Fluid is not full filled the pipe	Increase the flow rate
	2. Electrode was polluted	Clean the electrode if voltage of DS1 and DS2 > 1V.
	3. Fluid's conductivity is too small	If connect three terminals SIG 1, SIG 2, SIGGND. and the alarm disappears, which means the fluid's conductivity is small. Replace other kind of flowmeter
Flow rate indication is unstable	1. Grounding issue	Make sure meter is properly grounded to a good earth ground
	2. Air	Make sure fluid does not contain air bubbles
	3. Converter location – outside electrical interference	Make sure Converter is not too close to sources of electrical interference